

Монтажные позиции мотор-редукторов серии MHL(F)

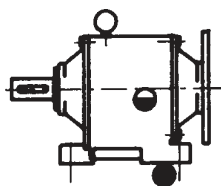

B3

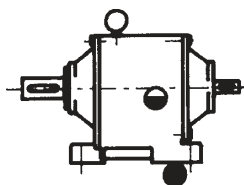
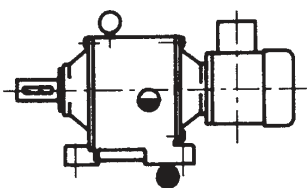
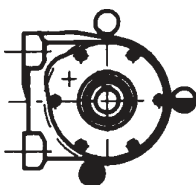
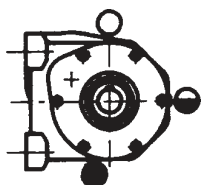
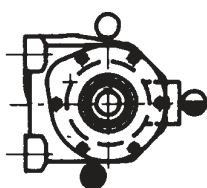

B6

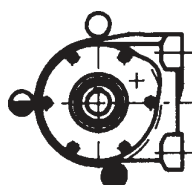
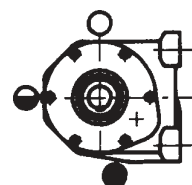
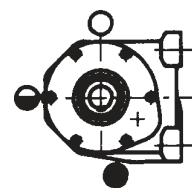

B7

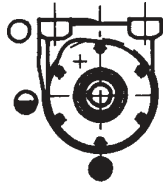
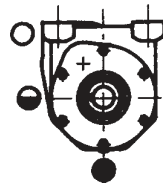

B8

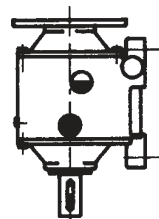
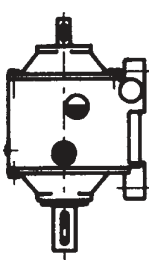
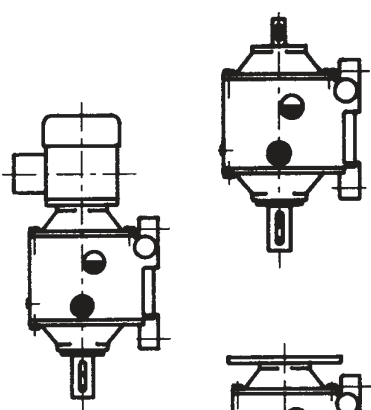

V5

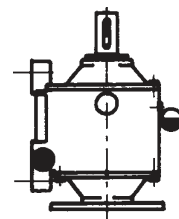
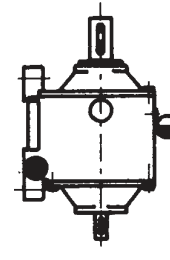
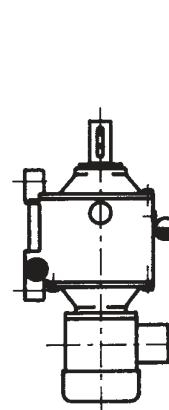

V6

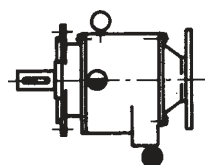
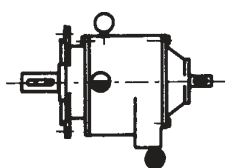
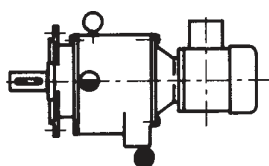

B5

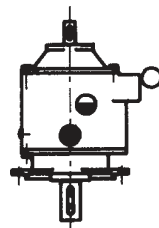
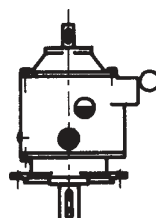
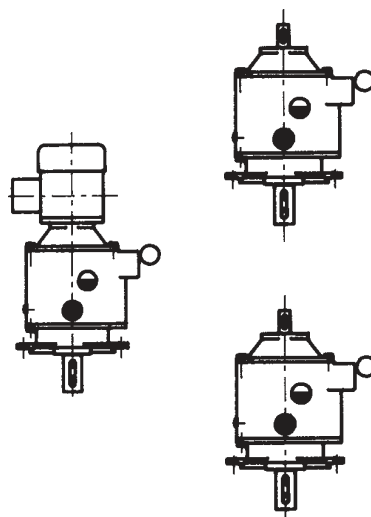

V1

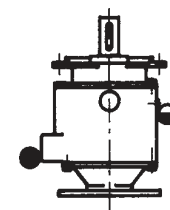
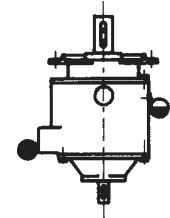
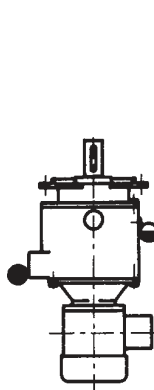

V3